

# Double Pitch Attachment Chain

## Bent Lug Attachments

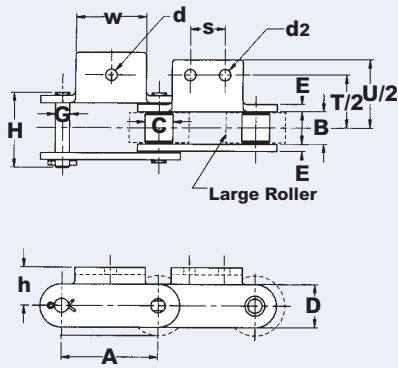

A-1 (Bent Lug 1 Side - 1 Hole)  
A-2 (Bent Lug 1 Side - 2 Holes)

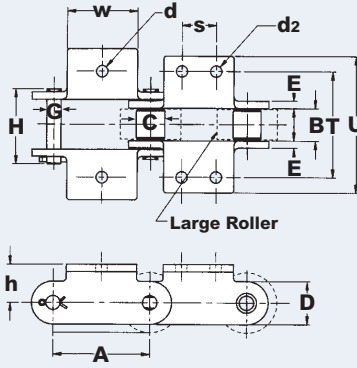

K-1 (Bent Lug 2 Sides - 1 Hole)  
K-2 (Bent Lug 2 Sides - 2 Holes)

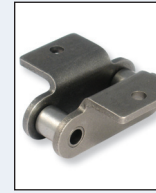

A-1

K-1

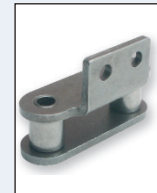

A-2

K-2

### A-1, A-2 & K-1, K-2 Double Pitch Attachment Dimensions

Dimensions are in inches unless otherwise indicated.

Chain No.	A-1 / K-1 Across Attach Holes	C/L to Attach Hole	A-1 / K-1 Overall Width	C/L to Attach End	A-1 / K-1 Hole Diameter	A-2 / K-2 Hole Diameter	C/L to Top of Attach	Attachment Hole Pitch	Tab Width	A-1 / A-2 Additional Wgt/Att	K-1 / K-2 Additional Wgt/Att
	T	T/2	U	U/2	d	d <sub>2</sub>	h	s	w	Lbs/Pc	Lbs/Pc
C2040 & C2042	1.000	0.500	1.520	0.760	0.138	0.138	0.358	0.375	0.750	0.007	0.014
C2050 & C2052	1.250	0.625	1.900	0.950	0.209	0.209	0.437	0.468	0.937	0.014	0.028
C2060H & C2062H	1.686	0.843	2.430	1.215	0.209	0.209	0.579	0.562	1.130	0.033	0.066
C2080H & C2082H	2.190	1.095	3.190	1.595	0.280	0.280	0.752	0.750	1.500	0.070	0.140
C2100H & C2102H	2.626	1.313	3.938	1.969	0.344	0.344	0.922	0.937	1.875	0.142	0.284
C2120H & C2122H	3.126	1.563	4.876	2.438	0.406	0.406	1.094	1.125	2.250	0.226	0.452
C2160H & C2162H	4.126	2.063	5.968	2.984	0.547	0.547	1.438	1.500	3.000	0.583	1.166

### Base Chain Dimensions

Chain No.	Pitch	Inside Width Min	Roller Diameter Max	Plate Height Max	Plate Thickness Max	Pin Diameter Max	Pin Length Max	Weight
	A	B	C	D	E/F	G	H	Lbs/Ft
<b>Standard Roller</b>								
C2040	1.000	0.309	0.312	0.465	0.059	0.157	0.701	0.34
C2050	1.250	0.370	0.400	0.591	0.079	0.200	0.858	0.56
C2060H	1.500	0.495	0.469	0.701	0.128	0.235	1.126	0.97
C2080H	2.000	0.620	0.625	0.949	0.160	0.313	1.409	1.63
C2100H	2.500	0.748	0.750	1.134	0.189	0.376	1.669	2.33
C2120H	3.000	1.000	0.875	1.382	0.221	0.437	2.063	3.31
C2160H	4.000	1.240	1.125	1.886	0.287	0.563	2.583	5.38
<b>Large Roller</b>								
C2042	1.000	0.309	0.625	0.465	0.059	0.157	0.701	0.55
C2052	1.250	0.370	0.750	0.591	0.079	0.200	0.858	0.85
C2062H	1.500	0.495	0.875	0.701	0.128	0.235	1.126	1.36
C2082H	2.000	0.620	1.125	0.949	0.160	0.313	1.409	2.26
C2102H	2.500	0.748	1.562	1.134	0.189	0.376	1.669	3.80
C2122H	3.000	1.000	1.750	1.382	0.221	0.437	2.063	5.31
C2162H	4.000	1.240	2.250	1.886	0.287	0.563	2.583	8.60

## Straight Lug Double Pitch Attachments

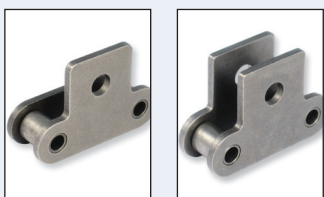

SA-1

SK-1

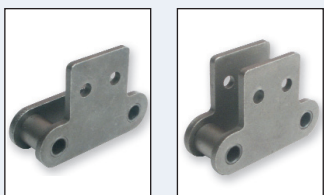

SA-2

SK-2

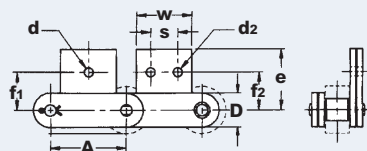
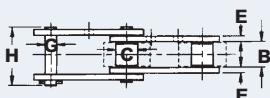

SA-1 (Straight Lug 1 Side - 1 Hole)  
SA-2 (Straight Lug 1 Side - 2 Holes)

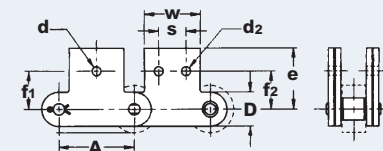
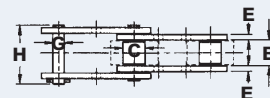

SK-1 (Straight Lug 2 Sides - 1 Hole)  
SK-2 (Straight Lug 2 Sides - 2 Holes)

### SA-1, SA-2 & SK-1, SK-2 Double Pitch Attachment Dimensions

Dimensions are in inches unless otherwise indicated.

Chain No.	SA-1 / SK-1 Hole Diameter	SA-2 / SK-2 Hole Diameter	C/L to Attach End	SA-1 / SK-1 C/L to Attach Hole	SA-2 / SK-2 C/L to Attach Hole	Attachment Hole Pitch	Tab Width	SA-1 / SA-2 Additional Wgt/Att	SK-1 / SK-2 Additional Wgt/Att
	d	d <sub>2</sub>	e	f <sub>1</sub>	f <sub>2</sub>	s	w	Lbs/Pc	Lbs/Pc
C2040 & C2042	0.209	0.138	0.783	0.437	0.531	0.375	0.750	0.007	0.014
C2050 & C2052	0.280	0.209	0.969	0.563	0.626	0.468	0.937	0.014	0.028
C2060H & C2062H	0.331	0.209	1.189	0.689	0.748	0.562	1.130	0.033	0.066
C2080H & C2082H	0.409	0.280	1.594	0.874	1.000	0.750	1.500	0.070	0.140
C2100H & C2102H	0.547	0.344	1.984	1.125	1.250	0.937	1.875	0.142	0.284
C2120H & C2122H	0.625	0.406	2.156	1.312	1.469	1.125	2.250	0.226	0.452
C2160H & C2162H	0.828	0.547	3.000	1.750	2.000	1.500	3.000	0.583	1.166

### Base Chain Dimensions

Chain No.	Pitch	Inside Width Min	Roller Diameter Max	Plate Height Max	Plate Thickness Max	Pin Diameter Max	Pin Length Max	Weight
	A	B	C	D	E/F	G	H	Lbs/Ft
Standard Roller								
C2040	1.000	0.309	0.312	0.465	0.059	0.157	0.701	0.34
C2050	1.250	0.370	0.400	0.591	0.079	0.200	0.858	0.56
C2060H	1.500	0.495	0.469	0.701	0.128	0.235	1.126	0.97
C2080H	2.000	0.620	0.625	0.949	0.160	0.313	1.409	1.63
C2100H	2.500	0.748	0.750	1.134	0.189	0.376	1.669	2.33
C2120H	3.000	1.000	0.875	1.382	0.221	0.437	2.063	3.31
C2160H	4.000	1.240	1.125	1.886	0.287	0.563	2.583	5.38
Large Roller								
C2042	1.000	0.309	0.625	0.465	0.059	0.157	0.701	0.55
C2052	1.250	0.370	0.750	0.591	0.079	0.200	0.858	0.85
C2062H	1.500	0.495	0.875	0.701	0.128	0.235	1.126	1.36
C2082H	2.000	0.620	1.125	0.949	0.160	0.313	1.409	2.26
C2102H	2.500	0.748	1.562	1.134	0.189	0.376	1.669	3.80
C2122H	3.000	1.000	1.750	1.382	0.221	0.437	2.063	5.31
C2162H	4.000	1.240	2.250	1.886	0.287	0.563	2.583	8.60

# Double Pitch Attachment Chain

## Extended Pin Attachments

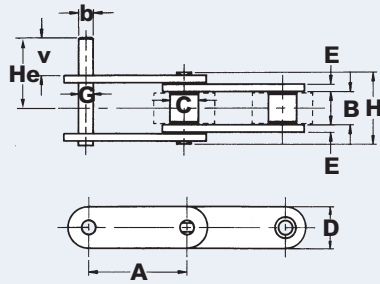

D-1 (1 Pin Extended Per Pin Link)

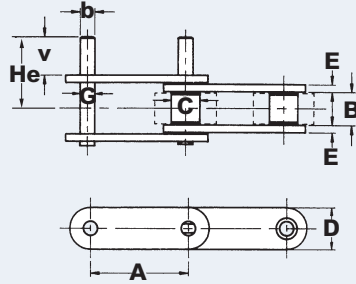

D-3 (2 Pins Extended Per Pin Link)

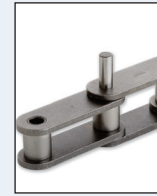

D-1

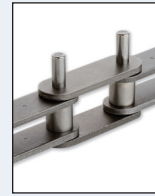

D-3

### D-1 & D-3 Double Pitch Attachment Dimensions

Dimensions are in inches unless otherwise indicated.

Chain No.	C/L to End of Ext Pin	Ext Pin Diameter	Ext Pin Projection	D-1 Additional Wgt/Att	D-3 Additional Wgt/Att
	He	b	v	Lbs/Pc	Lbs/Pc
C2040 & C2042	0.988	0.156	0.374	0.003	0.006
C2050 & C2052	1.228	0.200	0.469	0.004	0.008
C2060H & C2062H	1.642	0.235	0.563	0.007	0.014
C2080H & C2082H	2.100	0.313	0.752	0.015	0.030
C2100H & C2102H	2.616	0.375	0.937	0.026	0.052
C2120H & C2122H	3.140	0.437	1.125	0.044	0.088
C2160H & C2162H	3.960	0.563	1.500	0.099	0.198

### Base Chain Dimensions

Chain No.	Pitch	Inside Width Min	Roller Diameter Max	Plate Height Max	Plate Thickness Max	Pin Diameter Max	Pin Length Max	Weight
	A	B	C	D	E/F	G	H	Lbs/Ft
Standard Roller								
C2040	1.000	0.309	0.312	0.465	0.059	0.157	0.701	0.34
C2050	1.250	0.370	0.400	0.591	0.079	0.200	0.858	0.56
C2060H	1.500	0.495	0.469	0.701	0.128	0.235	1.126	0.97
C2080H	2.000	0.620	0.625	0.949	0.160	0.313	1.409	1.63
C2100H	2.500	0.748	0.750	1.134	0.189	0.376	1.669	2.33
C2120H	3.000	1.000	0.875	1.382	0.221	0.437	2.063	3.31
C2160H	4.000	1.240	1.125	1.886	0.287	0.563	2.583	5.38
Large Roller								
C2042	1.000	0.309	0.625	0.465	0.059	0.157	0.701	0.55
C2052	1.250	0.370	0.750	0.591	0.079	0.200	0.858	0.85
C2062H	1.500	0.495	0.875	0.701	0.128	0.235	1.126	1.36
C2082H	2.000	0.620	1.125	0.949	0.160	0.313	1.409	2.26
C2102H	2.500	0.748	1.562	1.134	0.189	0.376	1.669	3.80
C2122H	3.000	1.000	1.750	1.382	0.221	0.437	2.063	5.31
C2162H	4.000	1.240	2.250	1.886	0.287	0.563	2.583	8.60