

Steel Bushed/Knuckle Chain

Steel Bushed/Knuckle Chains keep elevators and conveyors operating in adverse conditions. Built to last in demanding applications, they are found in a variety of elevators and conveyor systems.

Pins and knuckles are press fit into punched and shaved holes in the sidebars to reduce wear and to maintain dimensional accuracy. The robust construction makes Steel Bushed/Knuckle Chains ideal replacements for cast chains when conditions become too severe.

Pins are heat-treated alloy steel or case-hardened steel. Knuckles are case-hardened alloy steel. Sidebars are either heat-treated medium carbon or alloy steel. Straight and offset sidebar constructions are offered.

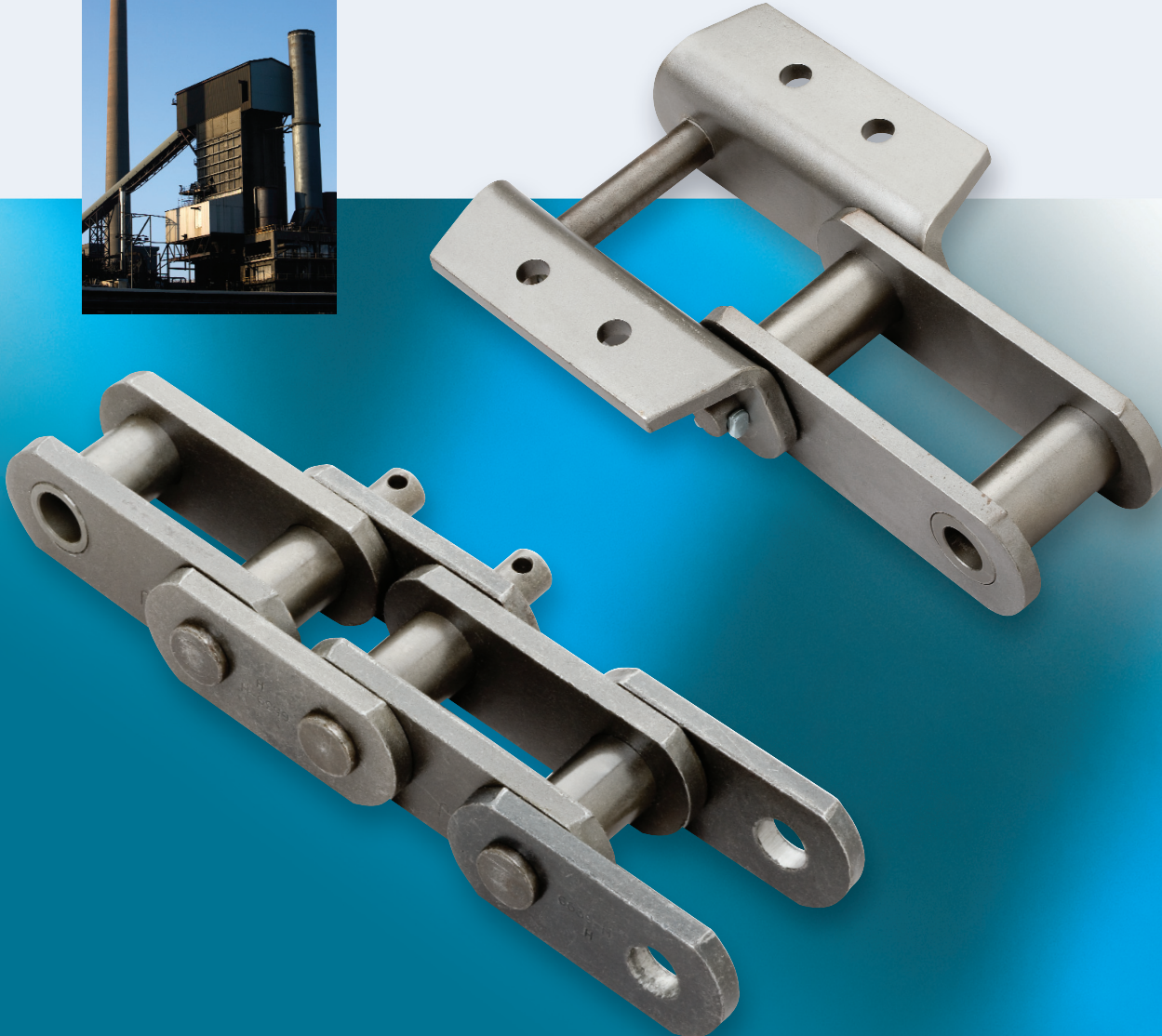

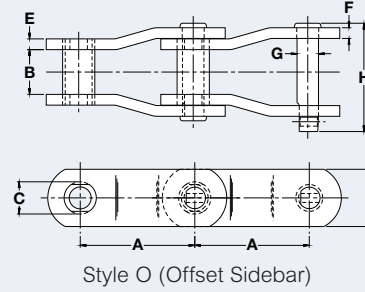
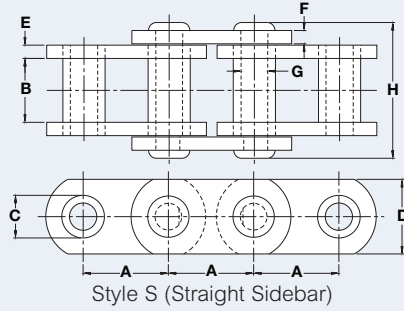

Engineering Class Steel Bushed/Knuckle Chain

Dimensions are in inches unless otherwise indicated.

Chain No.	Sidebar Style	Pitch	Inner Width Max	Bushing/Knuckle Diam Max	Plate Height Max	Inner Plate Thick Max	Outer Plate Thick Max	Pin Diam Max	Pin Length Max	Average Ultimate Strength	Rated Working Load	Weight
		A	B	C	D	E	F	G	H	Lbs	Lbs	Lbs/Ft
6188M	S	2.609	1.063	0.875	1.125	0.250	0.250	0.500	2.520	26,000	2,730	3.80
6131R	S	3.075	1.250	1.250	1.500	0.375	0.375	0.625	3.375	56,500	4,500	7.40
6382R	S	3.075	1.500	1.250	1.750	0.375	0.375	0.625	3.625	66,000	4,900	8.20
6102R	S	4.000	2.219	1.000	1.500	0.375	0.375	0.625	4.360	40,000	6,500	7.90
6825M	O	4.000	1.563	1.125	2.000	0.375	0.375	0.750	3.780	83,500	6,500	8.70
6102 1/2M	S	4.030	2.188	1.375	1.750	0.375	0.375	0.750	4.310	70,000	7,900	9.40
6111M	S	4.760	2.625	1.438	2.000	0.375	0.375	0.750	4.875	50,000	8,850	10.20
6111MSP	S	4.760/7.240	2.625	1.438	2.000	0.375	0.375	0.750	4.875	50,000	8,850	8.80
6130M	O	6.000	1.500	1.500	2.000	0.375	0.375	0.875	3.770	49,000	6,900	9.40
6810MB	O	6.000	2.125	1.250	1.500	0.375	0.375	0.625	4.200	56,600	6,300	6.50
6110R	S	6.000	2.125	1.250	1.750	0.375	0.375	0.625	4.200	63,500	6,200	6.40
6830R	O	6.000	1.563	1.125	2.000	0.375	0.375	0.750	3.810	66,000	6,070	7.50
6844M	S	6.000	2.500	1.125	2.000	0.500	0.500	0.750	5.160	70,000	9,200	10.40
6944R	O	6.000	2.500	1.120	2.000	0.500	0.500	0.750	5.160	70,000	9,200	12.70
6138R	S	6.000	2.625	1.438	2.000	0.375	0.375	0.750	4.840	83,000	8,800	14.30
6826	O	6.000	2.375	1.500	2.500	0.375	0.375	0.875	4.950	95,000	9,500	13.80
6956PB	S	6.000	3.000	1.750	3.000	0.500	0.500	1.000	5.922	144,500	16,000	18.40
6850	S	6.000	2.250	2.000	3.000	0.625	0.625	1.375	5.875	160,000	16,670	23.50
AC850	S	6.000	2.250	2.000	2.510	0.625	0.625	1.313	6.410	160,000	16,100	23.50
6866R	S	6.000	2.500	2.375	3.000	0.500	0.500	1.250	5.188	167,000	17,400	26.00
6867R	S	6.000	3.000	1.750	3.250	0.500	0.500	1.000	5.860	170,000	14,000	21.00
6869R	S	6.000	3.719	2.375	4.000	0.625	0.625	1.250	7.230	267,000	22,000	34.00
6969R	S	6.000	3.719	2.500	4.000	0.625	0.625	1.500	7.484	275,000	30,000	49.90
6150RM	S	6.050	3.313	1.750	2.500	0.500	0.500	1.000	6.110	124,000	15,000	17.20
6864R	S	7.000	3.719	2.375	4.000	0.625	0.625	1.250	7.220	267,000	22,000	31.00
6684R	S	7.000	3.750	2.500	4.000	0.625	0.625	1.375	7.250	270,000	24,000	48.50
6875R	S	7.000	3.750	2.500	4.000	0.625	0.625	1.500	7.530	275,000	30,000	46.50
6874	S	7.000	4.000	2.750	4.500	0.750	0.625	1.750	7.920	420,000	38,000	53.60
6859R	O	9.000	2.500	1.750	2.500	0.500	0.500	1.000	5.390	130,000	14,000	13.10
6859AR	O	9.000	2.500	1.750	2.500	0.500	0.500	1.000	5.390	155,000	14,000	16.40
6861R	O	9.000	2.250	2.000	3.000	0.625	0.625	1.375	5.625	162,000	16,000	24.30
6359R	S	9.000	3.310	1.750	3.000	0.500	0.500	1.000	6.109	162,500	17,300	19.50
6882R	S	9.000	3.000	2.375	3.500	0.620	0.620	1.500	6.560	224,000	24,500	32.70
6881AR	O	9.000	3.000	2.375	3.500	0.625	0.625	1.500	6.563	260,000	24,500	32.00
6889PB	O	9.000	2.750	2.750	4.000	0.625	0.625	1.623	6.188	260,000	26,000	35.50
6322CHR	O	12.000	2.000	1.500	2.250	0.375	0.375	0.750	4.160	61,000	7,250	7.10

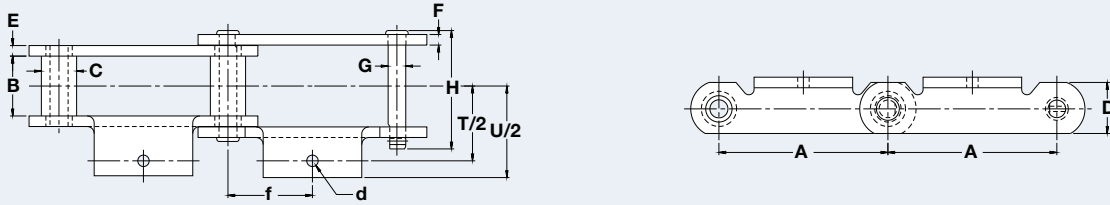

A-1 Steel Bushed/Knuckle Chain Attachments

Dimensions are in inches unless otherwise indicated.

Chain No.	A	B	C	D	E	F	G	H	T/2	U/2	d	f
6188M	2.609	1.062	0.875	1.125	0.250	0.250	0.500	2.515	1.875	2.578	0.406	1.305
6131R	3.075	1.250	1.250	1.500	0.375	0.375	0.625	3.360	2.047	2.641	0.406	1.538
6102R	4.000	2.219	1.000	1.500	0.375	0.375	0.625	4.328	2.375	3.455	0.406	2.000

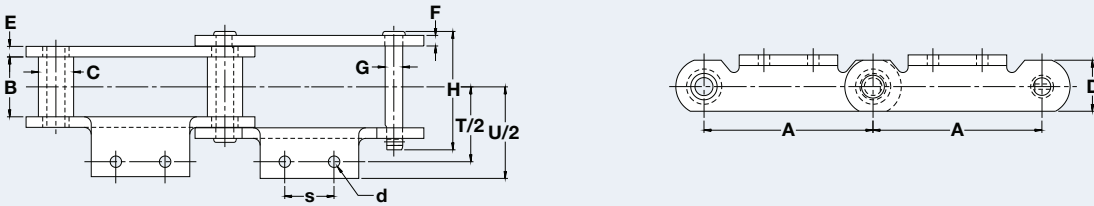

A-2 Steel Bushed/Knuckle Chain Attachments

Dimensions are in inches unless otherwise indicated.

Chain No.	A	B	C	D	E	F	G	H	T/2	U/2	d	s
6188M	2.609	1.063	0.875	1.125	0.250	0.250	0.500	2.563	2.094	2.563	0.313	1.250
6131R	3.075	1.250	1.250	1.500	0.375	0.375	0.625	3.406	2.047	2.625	0.500	1.500
6102R	4.000	2.219	1.000	1.500	0.375	0.375	0.625	4.328	2.657	3.250	0.375	1.750
6102 1/2M	4.030	2.188	1.375	1.750	0.375	0.375	0.750	4.375	2.688	3.219	0.375	1.750
6111M	4.760	2.625	1.438	2.000	0.375	0.375	0.750	4.922	3.125	3.875	0.500	2.313
6110R	6.000	2.125	1.250	1.500	0.375	0.375	0.625	4.031	2.657	3.188	0.375	1.750
6138R	6.000	2.625	1.438	2.000	0.375	0.375	0.750	4.843	3.125	3.875	0.531	2.313
6150RM	6.050	3.313	1.750	2.500	0.500	0.500	1.000	6.219	3.750	4.782	0.500	2.750

Contact Renold Jeffrey for weight specifications and for verification as dimensions are subject to change.

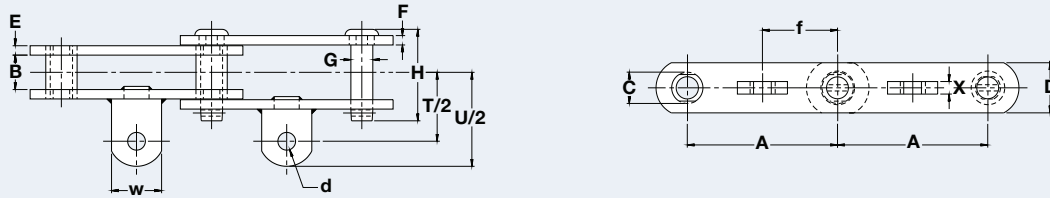

A-42 Steel Bushed/Knuckle Chain Attachments

Dimensions are in inches unless otherwise indicated.

Chain No.	A	B	C	D	E	F	G	H	T/2	U/2	X	d	f	w
6188M	2.609	1.063	0.875	1.125	0.250	0.250	0.500	2.563	1.781	2.344	0.375	0.391	1.304	1.125
6131R	3.075	1.250	1.250	1.500	0.375	0.375	0.625	3.406	2.500	3.125	0.375	0.563	1.538	1.500
6102½M	4.030	2.188	1.375	1.750	0.375	0.375	0.750	4.375	2.500	3.313	0.625	0.688	2.016	1.625

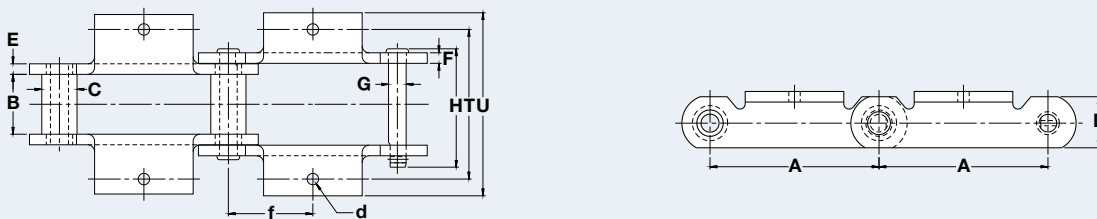

K-1 Steel Bushed/Knuckle Chain Attachments

Dimensions are in inches unless otherwise indicated.

Chain No.	A	B	C	D	E	F	G	H	T	U	d	f
6188M	2.609	1.062	0.875	1.125	0.250	0.250	0.500	2.515	3.750	5.156	0.406	1.305
6131R	3.075	1.250	1.250	1.500	0.375	0.375	0.625	3.360	4.094	5.281	0.406	1.538
6102R	4.000	2.219	1.000	1.500	0.375	0.375	0.625	4.328	4.750	6.910	0.406	2.000

Contact Renold Jeffrey for weight specifications and for verification as dimensions are subject to change.

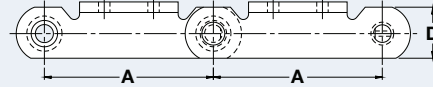
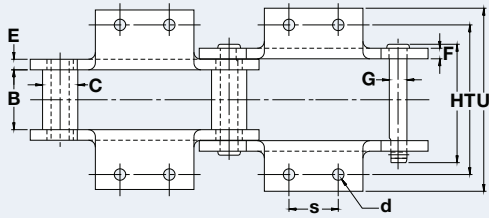

K-2 Steel Bushed/Knuckle Chain Attachments

Dimensions are in inches unless otherwise indicated.

Chain No.	A	B	C	D	E	F	G	H	T	U	d	s
6188M	2.609	1.063	0.875	1.125	0.250	0.250	0.500	2.563	4.188	5.125	0.313	1.250
6131R	3.075	1.250	1.250	1.500	0.375	0.375	0.625	3.406	4.094	5.250	0.500	1.500
6102R	4.000	2.219	1.000	1.500	0.375	0.375	0.625	4.328	5.313	6.500	0.375	1.750
6102 1/2M	4.030	2.188	1.375	1.750	0.375	0.375	0.750	4.375	5.375	6.438	0.375	1.750
6111M	4.760	2.625	1.438	2.000	0.375	0.375	0.750	4.922	6.250	7.750	0.500	2.313
6111MSP	4.760/7.240	2.625	1.438	2.000	0.375	0.375	0.750	4.922	6.250	7.375	0.500	2.313
6110R	6.000	2.125	1.250	1.500	0.375	0.375	0.625	4.031	5.313	6.375	0.375	1.750
6138R	6.000	2.625	1.438	2.000	0.375	0.375	0.750	4.843	6.250	7.750	0.531	2.313
6844M	6.000	2.500	1.125	2.000	0.500	0.500	0.750	5.219	6.563	8.188	0.500	2.750
6867R	6.000	3.000	1.750	3.250	0.500	0.500	1.000	5.938	7.750	9.313	0.688	2.750
6869R	6.000	3.719	2.375	4.000	0.625	0.625	1.250	7.234	9.000	11.000	0.688	3.000
6150RM	6.050	3.313	1.750	2.500	0.500	0.500	1.000	6.219	7.500	9.563	0.500	2.750
6864R	7.000	3.719	2.375	4.000	0.625	0.625	1.250	7.219	9.000	11.000	0.688	3.750

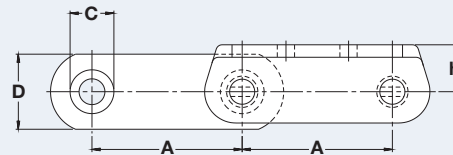
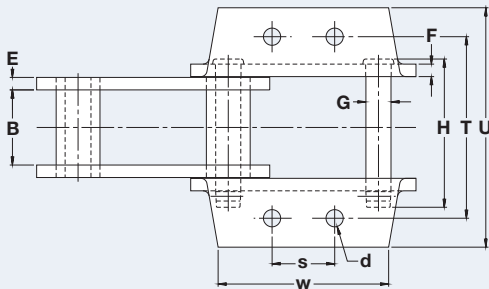

K-24 Steel Bushed/Knuckle Chain Attachments

Dimensions are in inches unless otherwise indicated.

Chain No.	A	B	C	D	E	F	G	H	T	U	d	h	s	w
6956PB	6.000	3.000	1.750	3.000	0.500	0.500	1.000	5.920	7.260	9.560	0.690	1.875	2.500	6.810

Contact Renold Jeffrey for weight specifications and for verification as dimensions are subject to change.

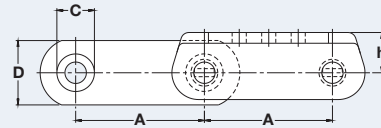
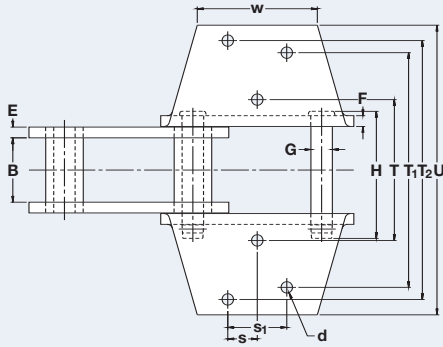

K-3 Steel Bushed/Knuckle Chain Attachments

Dimensions are in inches unless otherwise indicated.

Chain No.	A	B	C	D	E	F	G	H	T	T ₁	T ₂	U	d	h	s	s ₁	w
6956PB	6.000	3.000	1.750	3.000	0.500	0.500	1.000	5.922	6.563	6.031	12.063	13.500	0.531	1.875	2.750	1.375	5.594

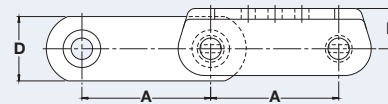
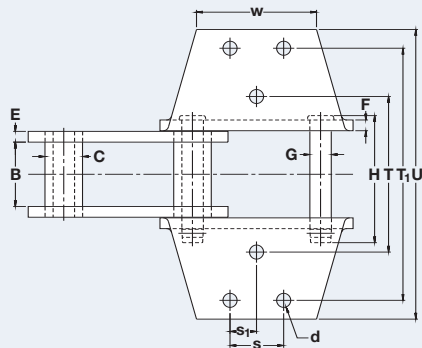

K-35 Steel Bushed/Knuckle Chain Attachments

Dimensions are in inches unless otherwise indicated.

Chain No.	A	B	C	D	E	F	G	H	T	T ₁	U	d	s	s ₁	w
6956PB	6.000	3.000	1.750	3.000	0.500	0.500	1.000	5.922	7.250	11.750	13.500	0.660	2.500	1.250	5.594

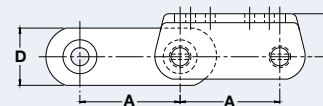
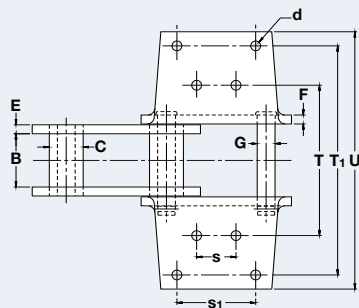

K-44 Steel Bushed/Knuckle Chain Attachments

Dimensions are in inches unless otherwise indicated.

Chain No.	A	B	C	D	E	F	G	T	T ₁	U	d	h	s	s ₁
6867R	6.000	3.000	1.750	3.250	0.500	0.500	1.000	7.000	12.000	14.000	0.563	2.500	3.500	3.500
6869R	6.000	3.719	2.375	4.000	0.625	0.625	1.250	9.000	13.000	15.000	0.688	3.000	2.750	4.500
6969R	6.000	3.719	2.500	4.000	0.625	0.625	1.500	9.000	13.000	15.000	0.688	3.000	2.750	4.500

Contact Renold Jeffrey for weight specifications and for verification as dimensions are subject to change.

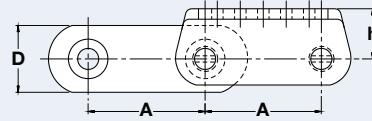
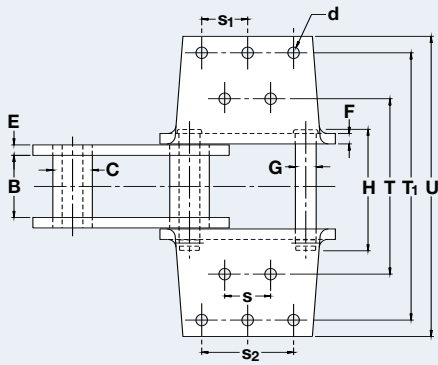

K-443 Steel Bushed/Knuckle Chain Attachments

Dimensions are in inches unless otherwise indicated.

Chain No.	A	B	C	D	E	F	G	H	T	T ₁	U	d	h	s	s ₁	s ₂
6684R	7.000	3.750	2.500	4.000	0.625	0.625	1.375	7.280	9.000	13.000	15.000	0.688	3.000	3.750	2.750	5.500
6864R	7.000	3.720	2.375	4.000	0.625	0.625	1.250	7.230	9.000	13.000	15.000	0.688	3.000	3.750	2.750	5.500
6874R	7.000	4.000	2.750	4.500	0.750	0.625	1.750	7.920	9.500	13.500	15.000	0.688	3.125	3.750	2.750	5.500
6875R	7.000	3.750	2.500	4.000	0.625	0.625	1.500	7.484	9.000	13.000	15.000	0.688	3.000	3.750	2.750	5.500

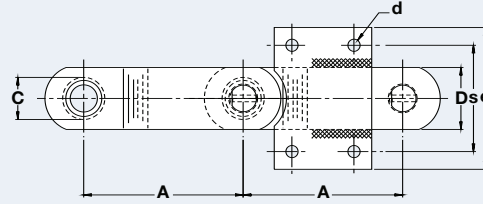
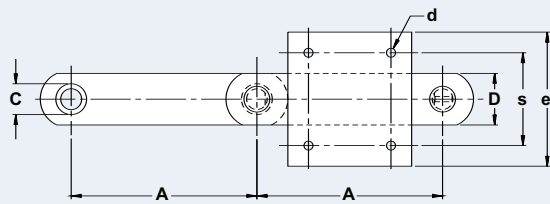
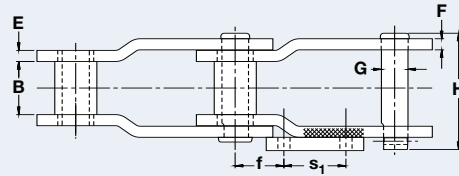
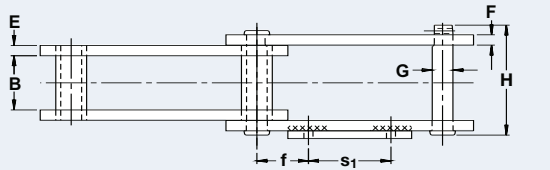

Style S (Straight Sidebar)

Style O (Offset Sidebar)

G-9 Steel Bushed/Knuckle Chain Attachments

Dimensions are in inches unless otherwise indicated.

Chain No.	Sidebar Style	A	B	C	D	E	F	G	H	d	e	f	s	s ₁
6359R	S	9.000	3.310	1.750	2.500	0.500	0.500	1.000	6.110	0.690	6.500	2.750	4.500	3.500
6859R	O	9.000	2.250	1.750	2.250	0.500	0.500	1.000	5.390	0.660	6.000	3.250	4.000	3.500
6881AR	O	9.000	3.000	2.375	3.500	0.625	0.625	1.500	6.563	0.688	8.000	2.750	6.000	3.500
6889PB	O	9.000	2.750	2.750	4.000	0.625	0.625	1.623	6.188	0.688	7.500	2.500	6.000	4.000

Contact Renold Jeffrey for weight specifications and for verification as dimensions are subject to change.